

BIDDING DOCUMENT

For

**Supply and Delivery of Manual
Meteorological Instruments**

Sealed Quotation

Contract ID No: 5/CD/DHM/074-75

Issued by:

Government of Nepal

Department of Hydrology and Meteorology

Naxal, Kathmandu

2017

Table of Contents

<u>Section I. Invitation for Sealed Quotation</u>	<u>2</u>
<u>Section III. Conditions of Contract</u>	<u>8</u>
<u>Section IV. Schedule of Requirements.....</u>	<u>13</u>
<u>Section V. Technical Specifications</u>	<u>14</u>
<u>Section VI. Sample Forms.....</u>	<u>14</u>

Section I. Invitation for Sealed Quotation

Government of Nepal
Ministry of population & Environment
Department of Hydrology and Meteorology
Invitation for Bids

Re-Advertisement:- **2074/8/15**

Department of Hydrology and Meteorology (DHM) invites sealed bid from Government of Nepal registered and eligible bidders for the Procurement of following goods.

S. N.	Contract ID No.	Description of Works	Price of Bidding document (Non-refundable (NRs)) and Bid validity Period	Bid security amount (NRs), Bid Security Validity Period, Ac. No. and Name of Bank	Last Date and Time of Purchase	Last Date and Time of Submission	Date and Time of Bid opening
1	5/CD/DHM/074-75	Supply and Delivery of Manual Meteorological Instruments	1000/- and 45 days	45,000/- and 75 days AC No. 1100 203 000 000 and Rastriya Banijya Bank, Thamel, Kathmandu, Nepal	2074/8/29 during office hour	2074/9/1 12:00 noon	2074/9/1 01:00 pm

- Bidding will be conducted through the National Competitive Bidding procedures as specified in the Public Procurement Act 2063 and Public Procurement regulation 2064. Eligible Bidders may obtain further information and inspect the bidding documents at the above office. +977 1 4433563 www.dhm.gov.np dhmprocurement@gmail.com
- Eligible and interested Bidders are invited to submit their unit rate for the goods described as in bidding documents with a certified copy of Company Registration Certificate, PAN/VAT Certificate, and Tax Clearance (2073/74)/ and Self Declaration letter of not being blacklisted till to submit date.
- Bidding documents may be purchased from the above office by eligible Bidders on the submission of a written application accompanied by a letter of Authority from the firm to the address above along with the copy of Company/Firm registration certificate. The payment mode may be direct deposit or bank transfer to the Gov. **Revenue A/c Title No.14227** on Rastriya Banijya Bank, Thamel, Kathmandu, Nepal or Bankers cheque payable to Department of Hydrology and Meteorology, Kathmandu, Nepal. **(Office Code No. 27-331-04, A/C No. ka-1-1-001)**
- Sealed bids must be submitted to the Procurement Unit of Department of Hydrology and Meteorology. Documents received after submission deadline shall not be accepted.
- Bids shall be opened in the presence of Bidder's representatives who choose to attend on the opening date given in above Table at the office of Department of Hydrology and Meteorology, P.O.Box 406, Nagpokhari, Naxal, Kathmandu, Nepal.
- If the last date of purchasing, submission and opening falls on a government holiday, then the next working day shall be considered the last day. In such a case the bid validity and bid security validity shall be recognized with effect from the original bid submission deadline.
- Bids should comply in all respects with the Instruction to Bidder included in the Bid Document. Non-compliance with these instructions shall result in disqualification.
- The Department of Hydrology and Meteorology reserves the right to accept or reject, wholly or partly any or all the bids without assigning reason, whatsoever.

Section II. Instructions to Bidder

- 1. Scope of Works** The Purchaser stated in the Invitation for Quotation invites bids for the supply and delivery of the goods as detailed in attached specifications, drawings and the bill of quantities provided herein. .
- 2. Eligible Bidder** This Invitation for Bids is open to all registered Suppliers with qualifications as described below:

 - a) Up to date Firm/Company Registration Certificate
 - b) VAT and PAN Registration Certificates
 - c) Tax Clearance Certificate of 2073/74
 - d) Power of Attorney
 - e) Other documents as needed
- 3. One Bid per Bidder** **Each Bidder shall submit only one quotation, A Bidder who submits more than one quotation shall cause all the quotations with the Bidder's participation to be disqualified.**
- 4. Content of Quotation Form** The Quotation Form comprise the documents listed below:

 1. Invitation for Sealed Quotations
 2. Instructions to Bidders
 3. General Conditions of Contract (GCC)
 4. Form of Agreement
 5. Sample Forms
 6. Schedule of Requirements
 7. Technical Specifications
- 5. Clarification** A prospective Supplier/Bidder may obtain clarification on the Quotation Form from the Purchaser stated in Invitation for Quotation.
- 6. Language of Quotation** All documents relating to the Quotation shall be in English or in Nepali.
- 7. Documents Comprising Quotation** The Quotation by the Bidder shall comprise the following:

 - a. Quotation and Price Schedules
 - b. Bid Security
 - c. Schedule of Requirements
 - d. Technical Specifications
- 8. Quotation Prices** The Bidder shall indicate on the appropriate Price Schedule the unit prices (where applicable) and total price of the goods to be supplied under the contract.

All duties, taxes and other levies payable by the Bidder under the contract shall be included in the rates, prices and total Bid Price submitted by the Bidder.

Price quoted by the Bidder shall remain fixed and valid until completion of the Contract Performance and will not be subject to variation in any account.

-
- 9. Quotation Validity** The Quotation shall remain valid for the period of 45 days after opening of the quotation.
- 10. Quotation Security** The Bidder shall furnish a Security in Nepali Rupees in the amount not less NRs. **45,000/-** (In words:- Nepali rupees **Forty five thousand only**).The Bid Security shall remain valid for a period of 75 days after opening of the quotation.
- The Security shall be in the form of cash voucher deposited in the Bank Account of the Employer specified in the notice for “Invitation for Quotation” or a bank guarantee from a bank acceptable to the Employer.
- 11. Format and Signing of Quotations** The Quotation shall be typed or written in indelible ink and shall be signed by an authorized person. Any entries or amendments including alternations, additions or corrections made shall be initialled by the same authorized person.
- 12. Sealing and Marking of Quotations** The Bidder shall submit his Quotation in sealed envelopes. The envelope shall be addressed to the Purchaser specified in the Invitation for Quotation and shall bear the name and identification number of the quotation.
- 13. Deadline for Submission of Quotations** Quotations shall be delivered to the Purchaser at the address no later than the time and date specified in the Invitation for Quotation.
- Date:- 2074/9/1
Time:- 12:00 noon
- 14. Late Quotation** Any Quotation received by the Purchaser after the deadline shall not be accepted and shall be returned unopened to the Bidder upon request.
- 15. Modification And Withdrawal** Quotations once submitted shall not be withdrawn or modified.
- 16. Bid Opening** The Purchaser shall open the Quotations in the presence of the Bidders' representatives who choose to attend at the time and in the place as specified in the Invitation for Quotation.
- Date:- 2074/9/1
Time:- 01:00 pm
Place:- Meeting Hall, Department of Hydrology and Meteorology, Naxal
- The Purchaser shall prepare and provide minutes of the opening including the information disclosed to those present.
- 17. Process to be Confidential** Information relating to the examination, evaluation and comparison of Quotations and recommendations for the award of a contract shall not be disclosed to Bidders or any other persons not officially concerned with such process until the award to the successful Bidder has been announced. Any efforts by the Bidder to influence the Purchaser in the Quotation evaluation, comparison or contract award decisions may result in rejection of Bidder's quotation.

-
- 18. Examination of Quotations** Prior to the detailed evaluation of Quotations, the Purchaser shall determine whether each Quotation (a) meets the eligibility criteria defined in Clause 2;
(b) has been properly signed; (c) is accompanied by the required securities; and (d) is substantially responsive to the requirements of the Bidding documents.
- 19. Evaluation and Comparison of Quotations**
- 19.1 In evaluating the Quotations, the Purchaser shall determine for each Quotation the evaluated Bid Price by adjusting any corrections for errors. Quotations shall be checked by the Purchaser for any arithmetic errors. Errors shall be corrected by the Purchaser as follows:
- a. where there is a discrepancy between the amounts in figures and in words, the amount in words shall govern; and
 - b. where there is a discrepancy between the unit rate and the line item total resulting from multiplying the unit rate by the quantity, the unit rate as quoted shall govern
- 19.2 If the Bidder does not accept the corrected amount, the Quotation shall be rejected and the Security pursuant to Clause 10 may be forfeited.
- 20. Award of Contract** The Purchaser shall decide the award of the contract, within 15 days of the opening of the quotation, to the Bidder whose Quotation is within the approved estimate and who has offered the lowest evaluated Bid Price, provided that such Bidder has been determined to be eligible in accordance with the provisions of Clauses 2.
- 21. Purchaser's Right to Accept or Reject** The Purchaser reserves the right to accept or reject any Quotation or to cancel the bidding process and reject all Quotations, at any time prior to the award of the contract, without assigning any reasons whatsoever and without thereby incurring any liability to the affected Bidder or Bidders.
- 22. Notification of Award and Signing of Agreement**
- 22.1 The Bidder whose Quotation is accepted and all other participating bidders shall be notified of the award by the Purchaser. Within 7 days of receipt of the notification, the successful Bidder shall deliver the Performance Security pursuant to Clause 23 and sign the Agreement.
- 22.3 Inability of the Bidder to make an Agreement within the above stated period shall result in cancellation of the Contract Award and forfeiture of the Bidder's Security, upon which the Contract shall then be awarded to the next successive successful Bidder.
- 23. Performance Security**
- 23.1 Within fifteen (7) days of the receipt of notification of award from the Purchaser, the successful Bidder shall furnish the Performance Security in accordance with the GCC, using for that purpose the Performance Security Form included in Section VIII, Contract Forms, or another form acceptable to the Purchaser.
- i) If bid price of the bidder selected for acceptance is up

to 15 (fifteen) percent less than the approved cost estimate, the performance security amount shall be 5 (five) percent of the bid price.

ii) For the bid price less than 15 percent of the cost estimate, the performance security amount shall be determined as follows:

Performance Security Amount = [(0.85 x Cost Estimate - Bid Price) x 0.5] + 5% of Bid Price.

The Bid Price and Cost Estimate shall be inclusive of Value Added Tax.

Section III. Conditions of Contract

- 1. Definitions**
- 1.1 In this contract, the following terms shall be interpreted as indicated:
- a. "The Contract" means the agreement entered into between the Purchaser and the Supplier, as recorded in the Contract Form Signed by the parties, including all attachments and appendices thereto and all documents incorporated by reference therein;
 - b. "The Contract Price" means the price payable to the Supplier under the contract for the full and proper performance of its contractual obligation;
 - c. "The Goods" means Equipment and related Accessories and spare-parts or any other materials which the Supplier is required to supply to the Purchaser under the contract;
 - d. "Services" means services ancillary to the supply of the goods such as transportation and insurance including the installation, commissioning and the operational and maintenance training of the supplied equipment.
 - e. "The Purchaser" means the procuring entity purchasing the goods;
 - f. "The Supplier" means the organization supplying the goods and services under this contract.
- 2. Technical Specification**
- 2.1 The goods supplied under this contract shall conform to the standards mentioned in the Technical Specification.
- 3. Patent Right**
- 3.1 The Supplier shall indemnify the Purchaser against all third-party claims of infringement of patent, trademark or industrial design rights arising from use of goods or any part thereof in the Purchaser's country.
- 4. Performance Security**
- 4.1 Within seven days (7) of receipt of award of contract from the Purchaser the successful Bidder shall furnish the performance security in accordance with the Sub - Clause 4.3 of the Conditions of Contract in the Performance Security Form provided in the Bidding Documents.
- 4.2 Failure of the successful Supplier to comply with the requirement of Sub - clause 4.1 shall constitute sufficient grounds for the annulment of the award and forfeiture of the bid security, in which event the Purchaser may make the award to the next lowest Supplier or call for new sealed quotations.
- 4.3 If bid price of the bidder selected for acceptance is up to 15 (fifteen) percent less than the approved cost estimate, the performance security amount shall be 5 (five) percent of the bid price.
- ii) For the bid price less than 15 percent of the cost estimate, the performance security amount shall be determined as follows:
- Performance Security Amount = [(0.85 x Cost Estimate - Bid Price) x 0.5] + 5% of Bid Price.
- The Bid Price and Cost Estimate shall be inclusive of Value

-
- Added Tax.
- 4.4 The validity of Performance Security shall be one (1) year after the final installation and commissioning of the Goods and the issue of final acceptance certificate to the Suppliers. The Supplier shall promptly extend the validity suitably to cover agreed extension of the warranty period of the supplied goods.
- 4.5 The performance security shall be released within 28 days of completion of warranty period and upon submission of claim by the Supplier.
- 5. Inspection and Tests**
- 5.1 The Purchaser or its Representative shall have the right to inspect and/or test the goods to confirm their conformity to the Technical Specification and the quality of performance after the supply and delivery of good to the Purchaser's premises.
- 6. Packing**
- 6.1 The Supplier shall provide such packing of the goods as is required to prevent their damage or deterioration during transmit to their final destination as indicated in the contract.
- 6.2 The packing shall be sufficient to withstand, without limitation, rough handling during transit and exposure to extreme temperatures, salt and precipitation during transit and open storage.
- 6.3 The packing, marking and documentation within and outside the packages shall comply strictly with such special requirements as shall be expressly provided in accordance with international standard and practice.
- 7. Delivery of Goods**
- 7.1 Delivery of the goods shall be made by the Supplier in accordance with the terms specified by the Purchaser in its Schedule of Requirements.
- 7.2 The terms "EXW", "FOB", "CIF", "CIP" etc., shall be governed by the rules prescribed in the current edition of INCOTERMS published by the International Chamber of Commerce (ICC), Paris.
- 8. Insurance**
- 8.1 The goods supplied under the contract shall be fully insured in the currency of the Sealed Quotation price against loss or damage incidental to manufacture or acquisition, transportation, storage and delivery in the manner specified.
- 8.2 Where delivery of the goods is required by the Purchaser on a CIF or CIP basis to a specified destination, the Supplier shall arrange and pay for insurance, naming the Purchaser as the beneficiary and the Supplier shall be required to meet all transport and storage expenses until delivery.
- 9. Warranty**
- 9.1 The Supplier warrants that all the goods supplied under the contract shall fully comply with the specification laid down in the contract.
- 9.2 The warranty shall remain valid for one year after the goods have been delivered to the final destination indicated in the contract, and accepted by the Purchaser after installation and commissioning of equipment by the Supplier.
- 9.3 The Purchaser shall promptly notify the Supplier in writing of

any claims arising under this warranty.

9.4 Upon receipt of such notice, the Supplier shall, with all reasonable speed, replace the defective goods without cost to the Purchaser. The Supplier will be entitled to remove, at its own risk and cost, the defective goods.

10. Payment

10.1 Payment shall be made in the currency in which the contract price has been stated in the Supplier's Sealed Quotation.

10.2 Payment of the goods supplied from within Nepal shall be made in Nepali Rupees after the delivery of goods to the satisfaction of the Purchaser.

10.3 Payment of the goods to be imported from abroad shall be made in the following manner:

Not applicable

11. Payment of Retention

11.1 Retention money will be 5% of the contract price

11.2 One half of the retention shall be repaid by the Employer to the contractor within 30 days upon expiry of Defects Liability Period and the Employer has certified that the notified defects have been corrected.

The remainder of the retention shall be paid by the Employer to the contractor within 7 days after submission of evidence document from the concerned Internal Revenue Office that the contractor has submitted his Income Returns

12. Defects Liability Period

12.1 After Completion of warranty period

13. Prices

11.1 Prices charged by the Supplier for goods delivered under the contract shall not vary from the prices quoted by the Supplier in its sealed quotation.

14. Changed Order

12.1 Where the Purchaser desires to make changes in **Schedule of Requirement**, it shall not exceed more than 15 percent.

15. Liquidated Damages

13.1 If the Supplier fails to deliver any or all of the goods within the time period specified in the contract, the Purchaser shall, without prejudice to its other remedies under the contract, deduct from the contract price, as liquidated damages, a sum equivalent to 0.05 percent of the contract price of delayed goods for each day of delay until actual delivery, up to a maximum deduction of 10 percent of the delayed goods' contract price. Once the maximum is reached, the Purchaser may consider termination of the contract.

16. Resolution of Disputes

14.1 If any dispute or difference of any kind whatsoever shall arise between the Purchaser and the Supplier in connection with or arising out of the Contract, the parties shall make every effort to resolve amicably such dispute or difference by mutual consultation.

14.2 If, after thirty (30) days, the parties have failed to resolve their dispute or difference by such mutual consultation, then either the Purchaser or Supplier may give notice to the other party of

it's intention to commence arbitration, as hereinafter provided, as to the matter in dispute, and no arbitration in respect of this matter may be commenced unless such notice is given.

14.2.1 Any dispute or difference in respect of such a notice of intention to commence arbitration has been given in accordance with this Clause shall be finally settled by arbitration. Arbitration may be commenced prior to or after delivery of the Goods under the Contract.

14.2.2 Arbitration proceedings shall be conducted in accordance with in accordance with the rules of Nepal Council of Arbitration (NEPCA).

14.3 Notwithstanding any reference to arbitration herein,

- a. the parties shall continue to perform their respective obligations under the Contract unless they otherwise agree; and
- b. the Purchaser shall pay the Supplier any monies due the Supplier.

17. Governing Language

15.1 The Governing Language shall be: Nepali or English

18. Applicable Law

16.1 The applicable law shall be Laws of Nepal.

19. Notices

17.1 Purchaser's address for notice purposes:

Name of Purchaser: Rajendra Sharma, Senior Divisional Hydrologist/Head(Procurement Unit)

Department of Hydrology and Meteorology

P.O.Box:- 406

City:- Naxal, Kathmandu

District: Kathmandu

Country:- Nepal

Telephone: +977-1-4433563

Email:-

17.2 Supplier's address for notice purposes:

20. Taxes and Duties

18.1 The Supplier shall be entirely responsible for all taxes, duties, licence fees and other such levies imposed by the GON.

21. Operation, Maintenance and Spare-parts Manuals

19.1 The successful Supplier shall supply 2 copies of manufacturer's operation, maintenance and spare-part manuals of the goods (Equipment).

22. Conduct of Suppliers

20.1 The Supplier shall be responsible to fulfil his obligations as per the requirement of the Contract Agreement, Bidding documents, GoN's Procurement Act and Regulations.

20.2 The Supplier shall not carry out or cause to carry out the following acts with an intention to influence the implementation of the procurement process or the procurement agreement :

- a. give or propose improper inducement directly or indirectly,

-
- b. distortion or misrepresentation of facts
 - c. engaging or being involved in corrupt or fraudulent practice
 - d. interference in participation of other prospective bidders.
 - e. coercion or threatening directly or indirectly to impair or harm, any party or the property of the party involved in the procurement proceedings,
 - f. collusive practice among bidders before or after submission of bids for distribution of works among bidders or fixing artificial/uncompetitive bid price with an intention to deprive the Purchaser the benefit of open competitive bid price..
 - g. contacting the Purchaser with an intention to influence the Purchaser with regards to the bid or interference of any kind in examination and evaluation of the bids during the period after opening of bids up to the notification of award of contract

23.Blacklisting Supplier

- 21.1 Without prejudice to any right of the Purchaser under this Contract, the GoN, Public Procurement and Monitoring Office(PPMO) may blacklist a Supplier for his conduct up to three years on the following grounds and seriousness of the act committed by the supplier:
 - a. if it is proved that the supplier committed acts pursuant to the Sub - clause 20.2,
 - b. if the supplier fails to sign an agreement pursuant to ITB Clause 22,
 - c. if it is proved later that the supplier had committed substantial defect in implementation of the contract or had not substantially fulfilled his obligations under the contract or the completed work is not of the specified quality as per the contract ,
 - d. if convicted by a court of law in a criminal offence which disqualifies the supplier from participating in the contract.
- 21.2 A Supplier declared blacklisted and ineligible by the GON shall be ineligible to bid for a contract during the period of time determined by PPMO.

Section IV. Schedule of Requirements

Name of Goods to be carried out

The goods should be delivered to Department of Hydrology and Meteorology, Nagpokhari, Naxal

S.N.	Name of Goods	Unit	Quantity	Earliest delivery Date	Latest delivery Date	Bidders offered d date
1	Maximum Thermometers	no.	25	45 days	75 days	
2	Minimum Thermometers	no.	25	45 days	75 days	
3	Ordinary Thermometers	no.	25	45 days	75 days	
4	Soil Thermometer (5cm)	no.	5	45 days	75 days	
5	Soil Thermometer (10cm)	no.	5	45 days	75 days	
6	Soil Thermometer (20cm)	no.	5	45 days	75 days	
7	Soil Thermometer Stand set with Net	no.	5	45 days	75 days	
8	Still well/stilling well for evaporation PAN	no.	3	45 days	75 days	
9	Galvanised inner cylinder	no.	40	45 days	75 days	
10	Evaporation PAN platform	no.	6	45 days	75 days	
11	Thermometer clamps with stand	no.	10	45 days	75 days	

Section V. Technical Specifications

Climate division of Department of Hydrology and Meteorology (DHM) is maintaining number of Precipitation, Climatological, Aero-Synoptic, Synoptic and Agro-meteorological stations to provide climate and water information for weather forecasting, agricultural activities, water resources planning, climatological analysis etc. Most of these stations are manual and various meteorological parameters -Air temperature, Relative Humidity, Sunshine duration, Evaporation, Soil temperature, wind speed and direction, Atmospheric pressure, Precipitation etc- are manually observed from the stations. The observed data are reported to the central office on regular time period.

In this fiscal, DHM intends to purchase manual instruments like thermometers, Pan platforms, Thermometers clamps with stand, soil thermometers stand with net as well as Inner Cylinders from its regular government budget.

Technical Specification details:

S.N	Name of Instrument	Specification required
1.	Maximum Thermometer	Maximum Thermometer (DIN 58654) Figure 1.
	Type	Sheathed type with the scale engraved on opal glass strip attached to the thermometer tube inside the sheath
	Measuring element	Mercury in glass with constriction in the bore
	Measuring range	-30 to +50°C
	Accuracy	< ± 0.2 °C
	Calibration range	-25 to +40°C
	Glass	Normal or borosilicate
	Graduation of scale	0.5°C
	Time constant (Response time)	20s-40s
	Dimension of thermometer	290mm long, 17-18mm diameter to fit the clamps in use
	Mercury	Double-distilled, degreased, repeatedly washed, and filtered
2.	Minimum Thermometer	Minimum Thermometer DIN 58653 Figure 2.
	Type	Sheathed type with the scale engraved on opal glass strip attached to the thermometer tube inside the sheath
	Measuring element	Ethyl alcohol in glass with dark glass index

	Measuring range	-30 to +50°C
	Accuracy	< ± 0.2 °C
	Calibration range	-30 to +30°C
	Glass	Normal or borosilicate
	Graduation of scale	0.5°C
	Time constant (Response time)	20s-40s
	Dimension of thermometer	290mm long, 17-18mm diameter to fit the clamps in use
	Ethyl alcohol	Pure Ethyl alcohol free of acetone
3.	Ordinary Thermometers	Ordinary Thermometers (DIN 58660) Figure 3.
	Type	Double Sheathed type with the scale engraved on opal glass strip attached to the thermometer tube inside the sheath
	Measuring element*	Mercury in glass
	Measuring range	-30 to +50oC
	Accuracy*	< ± 0.2 oC
	Calibration range	-25 to +40oC
	Glass*	Normal or borosilicate
	Graduation of scale*	0.2oC
	Time constant (Response time)*	20s-40s
	Mercury*	Double-distilled, degreased, repeatedly washed, and filtered

4.	Soil Thermometer of different Immersion depth	According with Liquid expansion thermometer DIN 58655 Figure 4.
	Type Immersion depth	5 cm, 10 cm, 20 cm
	Measuring element	Mercury in glass
	Measuring range for 5 cm	-25 to 45°C
	Measuring range for 10 cm	-20 to 40°C
	Measuring range for 20 cm	-15 to 35°C
	Measuring range for 30 cm	-15 to 35°C
	Accuracy	±0.3 °C at > 50 °C ±0.2 °C at + 50 °C ±0.4 °C at < 0 °C
	Glass	Normal or borosilicate
	Graduation of scale	0.2°C
Dimension of thermometer	150° bent angle.	
5.	Soil Thermometer Net & stand.	Net and stand for Thermometer DIN 58655 bent soil thermometer. Figure 5.
	Dimension & shape (Net).	Described as per figure 5. Four leg (150mm) of stand should be Sharp pointed to fix deep into land. Side way opening door with locking system.
	Material (Net)	Aluminum 4mm chicken wire mesh, Iron with Rust proof metallic white paint.
	Dimension & shape (soil thermometer stand)	Described as per figure 5.1.
	Material (soil thermometer stand)	Iron with Rust proof metallic white paint.

6.	Stillwell or Stilling well :	Material: Brass or Stainless steel Figure 6.
		Dimensions : 100mm Diameter x 254mm Height As per in figure.
		Thickness: 1.83mm(13 gauge)
		Notes: <ol style="list-style-type: none"> 1. Stilling well should have three leveling screw in bottom. 2. One small openings (hole) in bottom to permit the flow of water in and out of the well. 3. FAIRMOUNT FM9000 Hook gauge should fit over stilling well with adequate space for easy setting.
7.	Thermometer Clamps for maximum, minimum and ordinary thermometers of DIN 58654, 58653 and 58660 standard, respectively.	Single tripod stand with rod to firmly hold all four thermometer clamps. It consists of two vertical clamps to firmly hold ordinary thermometers (DIN 58660 of 37.5cm length & wider upper diameter 2cm) and one clamp to hold maximum and minimum thermometers (DIN 58654 and DIN58653 of 29 cm length & wider upper diameter 2cm). Figure 7.
		Size: Total length of stand 510mm
		Color : white metallic paint
		Material: Stainless steel or galvanized iron.
		Note: <ul style="list-style-type: none"> • These clamps should fit inside the Stevenson screen of dimension • The Holder grip should be strong enough to hold thermometer and can easily be taken out and put back in day to day operation of thermometers.
8	Galvanize Inner cylinder.	Type: 64mm (6.4cm) diameter-uniformity in diameter up to total height length, 450mm (45cm) height length. With holding ring side by. Figure 8.
		Color : Galvanization
		Material: Inner cylinder-24 gaze galvanize.
		Note: Inner cylinder should strong enough to bear cold harsh condition & leakage proof.

9.	Evaporation Pan platform	Type: Wooden evaporation pan for US Class A Evaporation pan. (As in Figure 9)
		Size: 1210mm*1210mm
		Dimension of Wooden Bar: 1210mm x 100mm x 50mm Gap of lower wooden bar 270mm between each bar and gap between upper wooden bar 177.5mm
		No of Wooden Bar: 4 wooden bar on lower part and 5 wooden bar on upper part. *Note. All wooden bar should be of same dimension.
		Color: White enamel painted.
		Material: Agrakha Wood.
		Notes: - All Wooden bar should be strongly nailed. Overlapping both upper and lower part should be total height of 100mm.

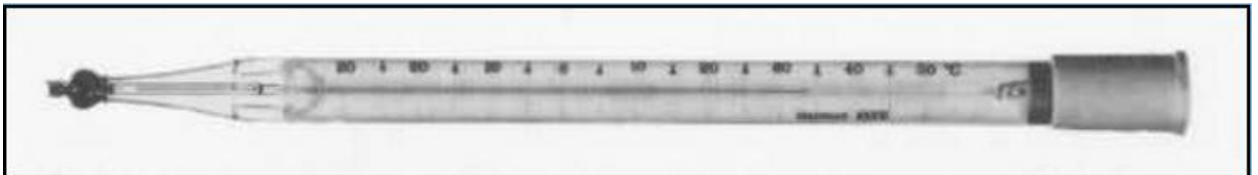

Figure 1.

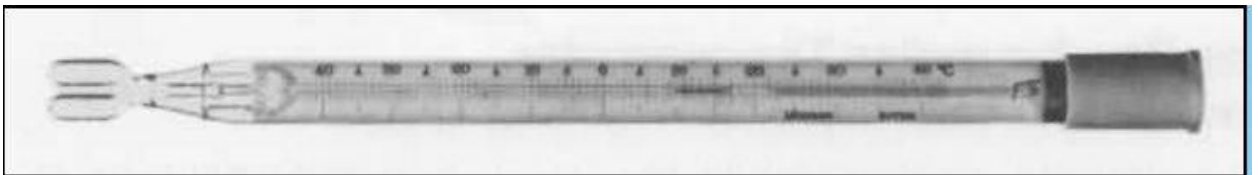

Figure 2.



Figure 3.



Figure 4.

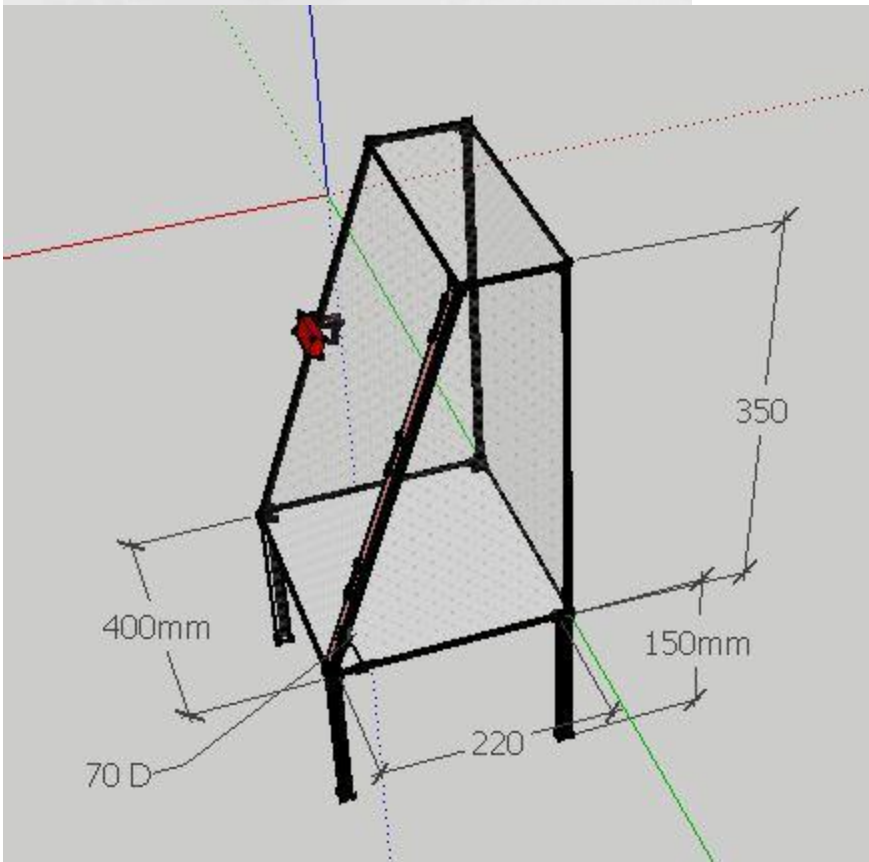

Figure 5.

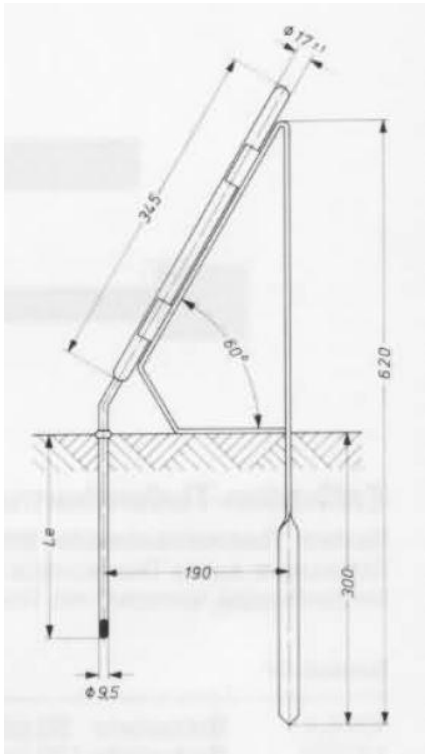

Figure 5.1.

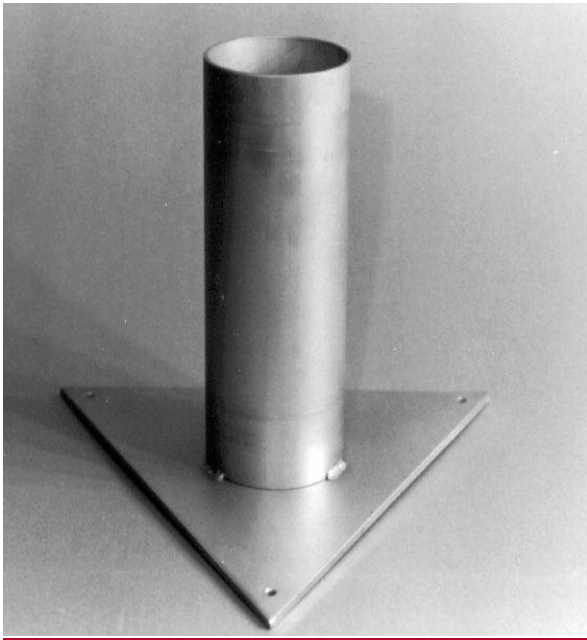

Figure 6.

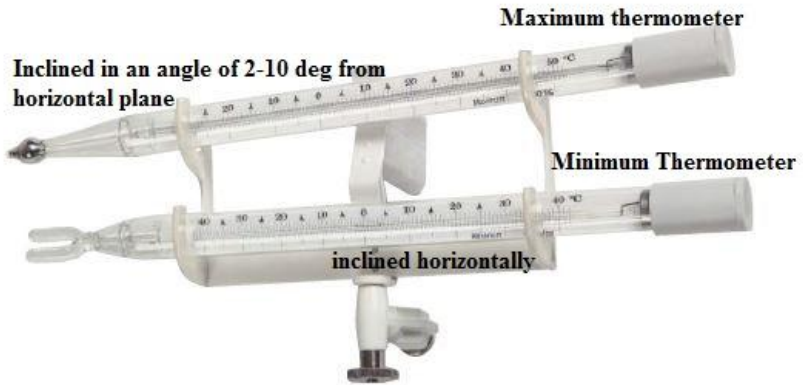
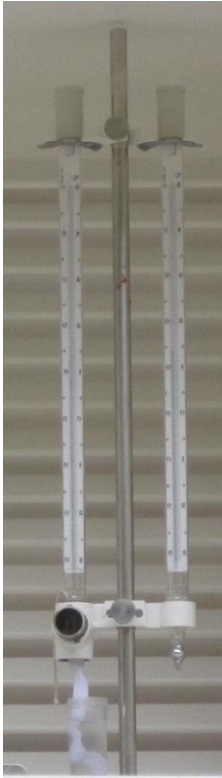

Figure thermometer clamp



Figure 7.

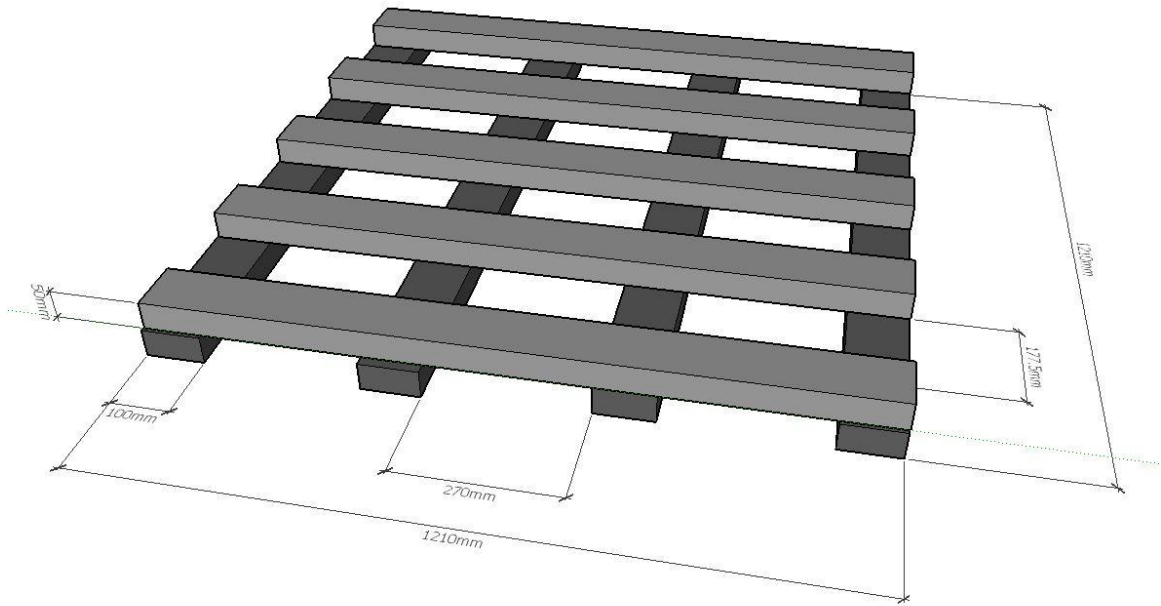

Figure 8.

Section VI. Sample Forms

1. Quotation and Price Schedules

Date:

To: *Department of Hydrology and Meteorology, Naxal, Kathmandu, Nepal*

Gentlemen and/or Ladies:

Having examined the Sealed Quotation (SQ) documents, we the undersigned, offer to “**Supply and Delivery of Manual Meteorological instruments**” in conformity with the said SQ documents for the sum of *[total SQ amount in words and figures]* or such other sums as may be ascertained in accordance with the Schedule of Prices attached herewith and made part of this SQ.

We undertake, if our SQ is accepted, to deliver the goods in accordance with the delivery schedule specified in the Schedule of Requirements.

If our SQ is accepted, we will obtain the guarantee of a bank in a sum equivalent to Five (5) percent of the Contract Price for the due performance of the Contract, in the form prescribed by the Purchaser.

We agree to abide by this SQ for a Period of **45** days from the date fixed for SQ opening it shall remain binding upon us and may be accepted at any time before the expiration of that period.

Until a formal Contract is prepared and executed, this SQ, together with your written acceptance thereof and your notification of award, shall constitute a binding Contract between us.

We understand that you are not bound to accept the lowest or any SQ you may receive.

Dated this _____ day of _____ 20_____.

[signature]

[in the capacity of]

Duly authorized to sign SQ for and on behalf of _____

Price Schedule for goods and related services

Name of Supplier _____ . _____ . Page . of ____

Item	Description	Country of Origin	Quantity	<u>Unit price[1] EXW</u>		Total price EXW (in NRs) (cols. 4x5)
				(in NRs)		
				In Figure	In Words	
1	2	3	4	5		4x5=6
1	Maximum Thermometers		25			
2	Minimum Thermometers		25			
3	Ordinary Thermometers		25			
4	Soil Thermometer (5cm)		5			
5	Soil Thermometer (10cm)		5			
6	Soil Thermometer (20cm)		5			
7	Soil Thermometer Stand set with Net		5			
8	Still well/stilling well for evaporation PAN		3			
9	Galvanised inner cylinder		40			
10	Evaporation PAN platform		6			
11	Thermometer clamps with stand		10			
	Total					
	VAT 13%					
	Grand Total					

Total Price to final destination (In Word)

Signature of Bidder _____

Note: In case of discrepancy between unit price and total, the unit price shall prevail.

2. Bid Security

Date:

To: *Department of Hydrology and Meteorology, Naxal, Kathmandu, Nepal*

Whereas, *[name of Bidder]* (hereinafter called “the Bidder”) has submitted his Sealed Quotation (SQ) dated *[date of submission of SQ.]* for the **Supply and Delivery of Manual Meteorological Instruments** (hereinafter called “the Sealed Quotation”).

KNOW ALL PEOPLE by these presents that WE *[name of Bank]* of Nepal having our registered office at *[address of bank]* (hereinafter called “the Bank”) are bound unto *[name of the procuring entity]* (hereinafter called “the Purchaser”) in the sum of *[specify amount in figure and words]* for which payment well and truly to be made to the said Purchaser, the Bank binds itself, its successors, and assigns by these presents. Sealed with the Common Seal of the said Bank this _____ day of _____ 20____.

THE CONDITIONS of this obligation are:

- (1) If, the Bidder withdraws its SQ during the period of bid validity specified by the Bidder on the SQ Form; or
- (2) If the Bidder having been notified of the acceptance of its SQ by the Purchaser during the period of bid validity:
 - (a) Fails or refuses to execute the Contract Form, if required; or
 - (b) Fails or refuses to furnish the performance security, in accordance with the Instruction to Bidders;

we undertake to pay to the Purchaser up to the above amount upon receipt of its first written demand, without the Purchaser’s having to substantiate its demand, provided that in its demand the Purchaser will note that the amount claimed by it is due to it owing to the occurrence of one or both of the two conditions, specifying the occurred condition or conditions.

This guarantee will remain in force up to Seventy five (75) days from the date of opening of the Sealed Quotation, and any demand in respect thereof should reach the Bank not later than the above date.

[signature of the bank]

[common seal of the bank]

3. Form of Agreement

THIS AGREEMENT made the day of 2074 between *Department of Hydrology and Meteorology, Naxal, Kathmandu, Nepal* (hereinafter called “the Purchaser”) of the one part and *Real Time Solutions P.Ltd., Dhobighat, Lalitpur, Nepal* (hereinafter called “the Supplier”) of the other part:

WHEREAS the Purchaser invited Sealed Quotation for certain goods and ancillary services, viz., **Supply and Delivery of Manual Meteorological Instruments** and has accepted a SQ. by the Supplier for the supply of those goods and services in the sum of *NRs.- (Nepali rupeesonly) with VAT* (hereinafter called “the Contract Price”).

NOW THIS AGREEMENT WITNESSETH AS FOLLOWS:

1. In this Agreement words and expressions shall have the same meanings as are respectively assigned to them in the Conditions of Contract referred to.
2. The following documents shall be deemed to form and be read and construed as part of this Agreement, viz.:
 - a. Quotation Form and the Price Schedule submitted by the Supplier;
 - b. The Schedule of Requirements;
 - c. The Technical Specifications;
 - d. The Conditions of Contract; and
 - e. The Purchaser’s Notification of Award.
3. In consideration of the payments to be made by the Purchaser to the Supplier as hereinafter mentioned, the Supplier hereby covenants with the Purchaser to provide the goods and services and to remedy defects therein in conformity in all respects with the provisions of the Contract.
4. The Purchaser hereby covenants to pay the Supplier in consideration of the provision of the goods and services and the remedying of defects therein, the Contract Price or such other sum as may become payable under the provisions of the contract at the times and in the manner prescribed by the Contract.

IN WITNESS whereof the parties hereto have caused this Agreement to be executed in accordance with their respective laws the day and year first above written.

On behalf of the Purchaser

On behalf of the Supplier

Name: Durga Prakash Manandhar

Name: Richa Shrestha

Designation: Deputy Director General

Designation: Requirement Analyst

Sign:

Sign:

Seal:

Seal:

5. Performance Security

Date :

To: *Department of Hydrology and Meteorology, Naxal, Kathmandu, Nepal*

WHEREAS *[name of Supplier]* (hereinafter called “the Supplier”) has undertaken, in pursuance of Contract No. *[reference number of the contract]* dated _____ 20____ to **Supply and Delivery of Manual Meteorological Instruments** (hereinafter called “the Contract”).

AND WHEREAS it has been stipulated by you in the said Contract that the Supplier shall furnish you with a bank guarantee by a reputable bank for the sum specified therein as security for compliance with the Supplier’s performance obligations in accordance with the Contract.

AND WHEREAS we have agreed to give the Supplier a guarantee:

THEREFORE WE hereby affirm that we are Guarantors and responsible to you, on behalf of the Supplier, up to a total of *[amount of the guarantee in words and figures]*, and we undertake to pay you, upon your first written demand declaring the Supplier to be in default under the Contract and without cavil or argument, any sum or sums within the limits of *[amount of guarantee]* as aforesaid, without your needing to prove or to show grounds or reasons for your demand or the sum specified therein.

This guarantee is valid until the _____ day of _____ 20_____.

Signature and seal of the Guarantors

[name of bank or financial institution]

[address]

[date]

6. Bank Guarantee for Advance Payment

To: *Department of Hydrology and Meteorology, Naxal, Kathmandu, Nepal*

[name of Contract]

Gentlemen and/or Ladies:

In accordance with the payment provision included in the Contract, which amends Clause 10 of the General Conditions of Contract to provide for advance payment, *[name and address of Supplier]* (hereinafter called “the Supplier”) shall deposit with the Purchaser a bank guarantee to guarantee its proper and faithful performance under the said Clause of the Contract in an amount of *[amount of guarantee in figures and words]*.

We, the *[bank or financial institution]*, as instructed by the Supplier, agree unconditionally and irrevocably to guarantee as primary obligator and not as surety merely, the payment to the Purchaser on its first demand without whatsoever right of objection on our part and without its first claim to the Supplier, in the amount not exceeding *[amount of guarantee in figures and words]*.

We further agree that no change or addition to or other modification of the terms of the Contract to be performed there under or of any of the Contract documents which may be made between the Purchaser and the Supplier, shall in any way release us from any liability under this guarantee, and we hereby waive notice of any such change, addition, or modification.

The validity period of the guarantee shall be 30 days beyond the period scheduled for repayment of the advance payment and the guarantee shall remain valid and in full effect from the date of the advance payment under the Contract until the Purchaser receives full repayment of the same amount from the Supplier.

Yours truly,

Signature and seal of the Guarantors

[name of bank or financial institution]

[address]

[date]